

VESTIÁRIO ÁRTIBROS 01
PLANTA
ESC. 1:25

VESTIÁRIO ÁRTIBROS 01
VISTA A
ESC. 1:25

VESTIÁRIO ÁRTIBROS 01
VISTA B
ESC. 1:25

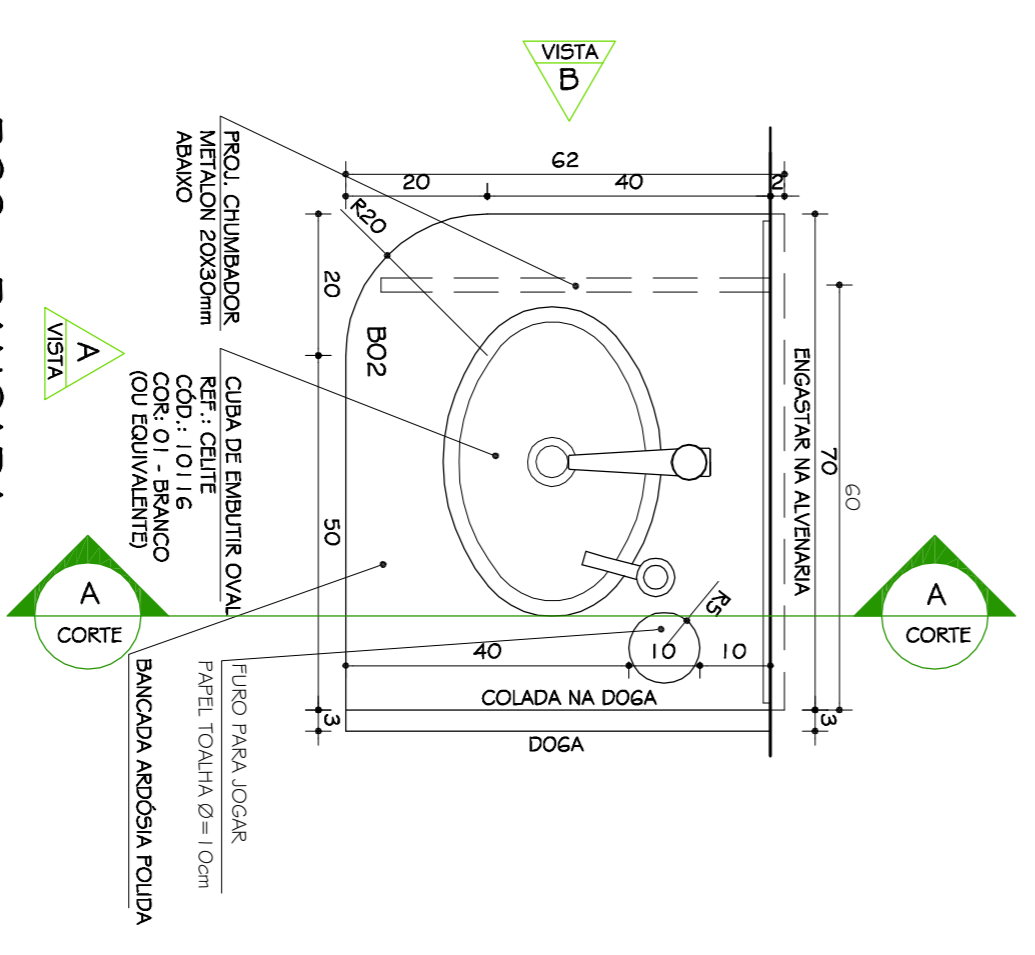
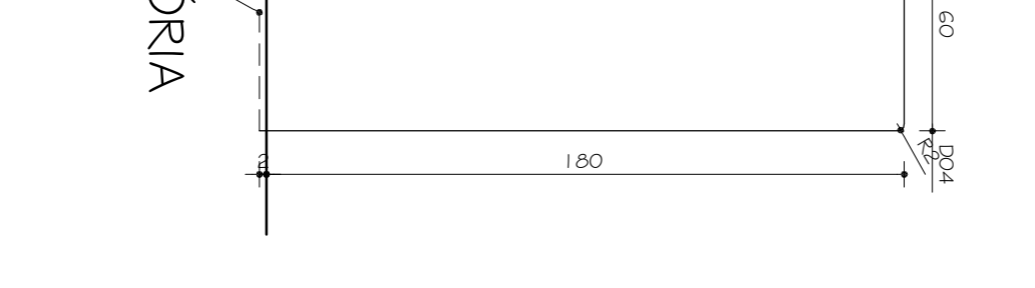
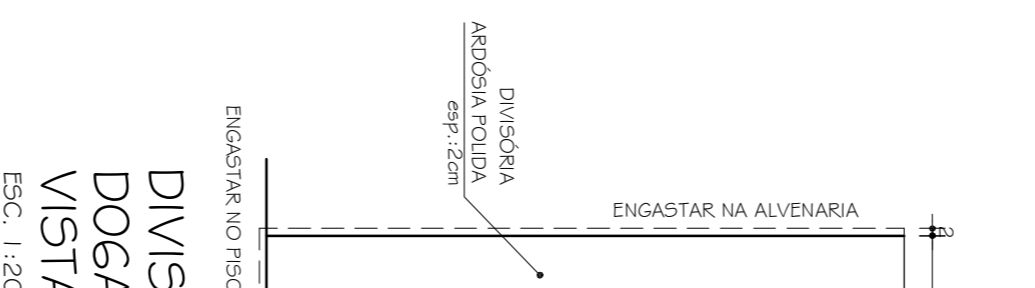
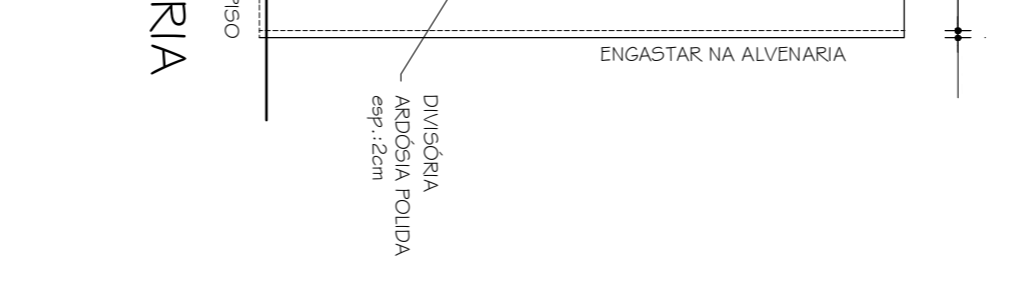
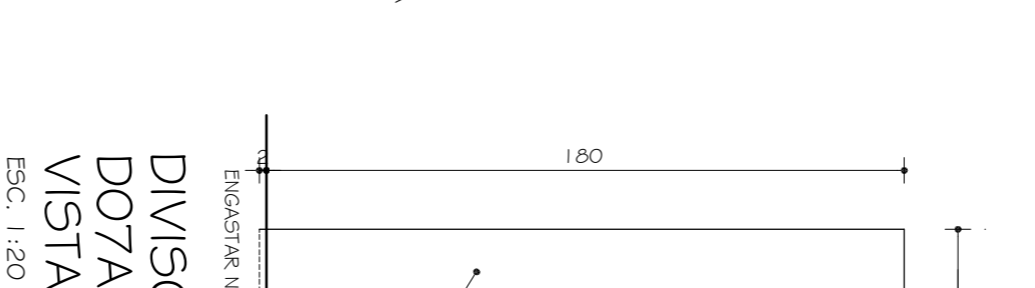
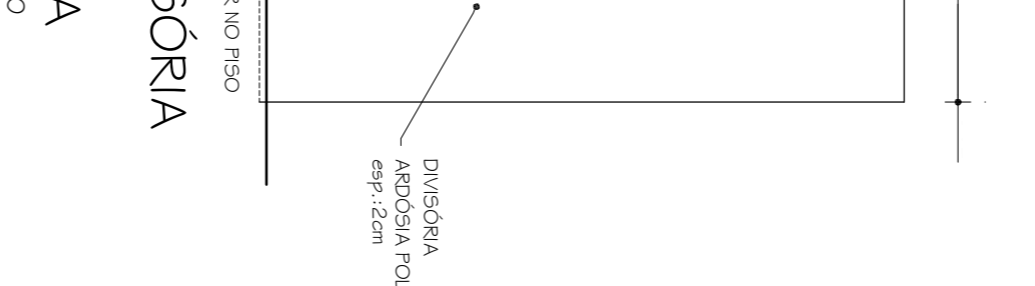
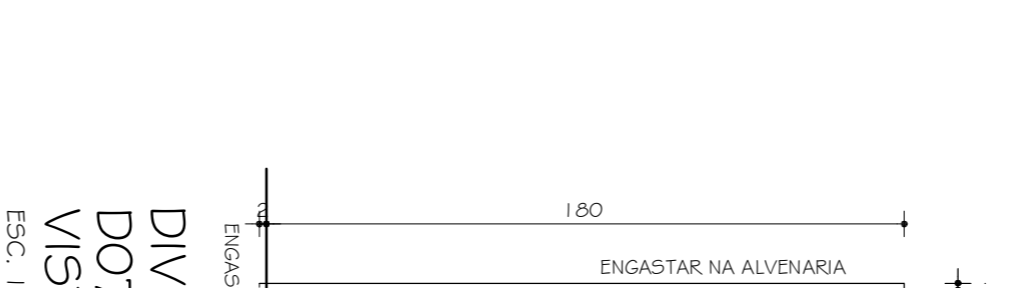
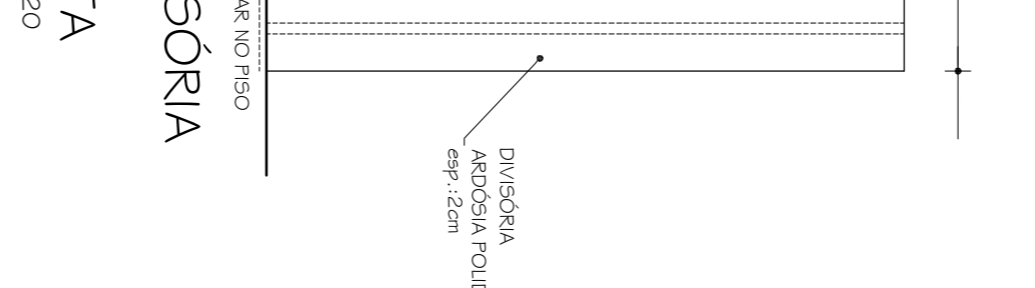
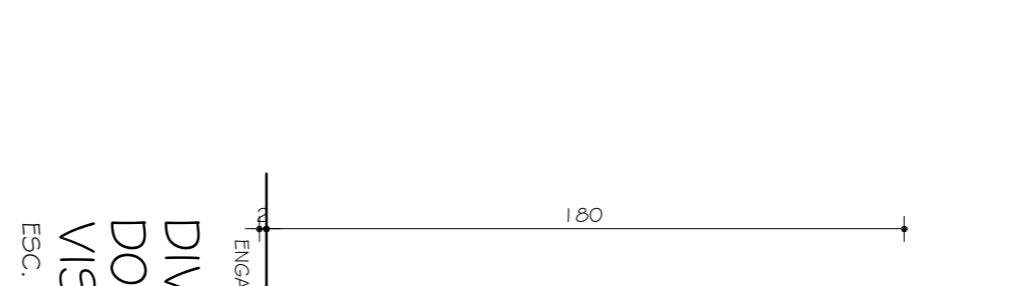
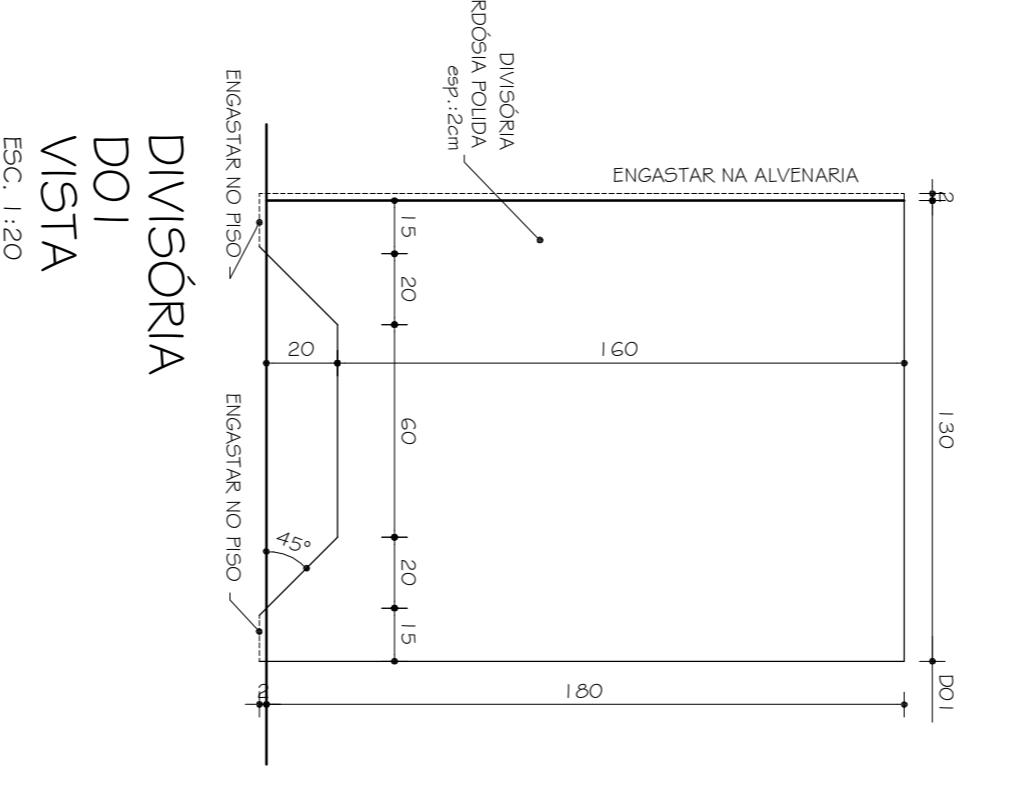
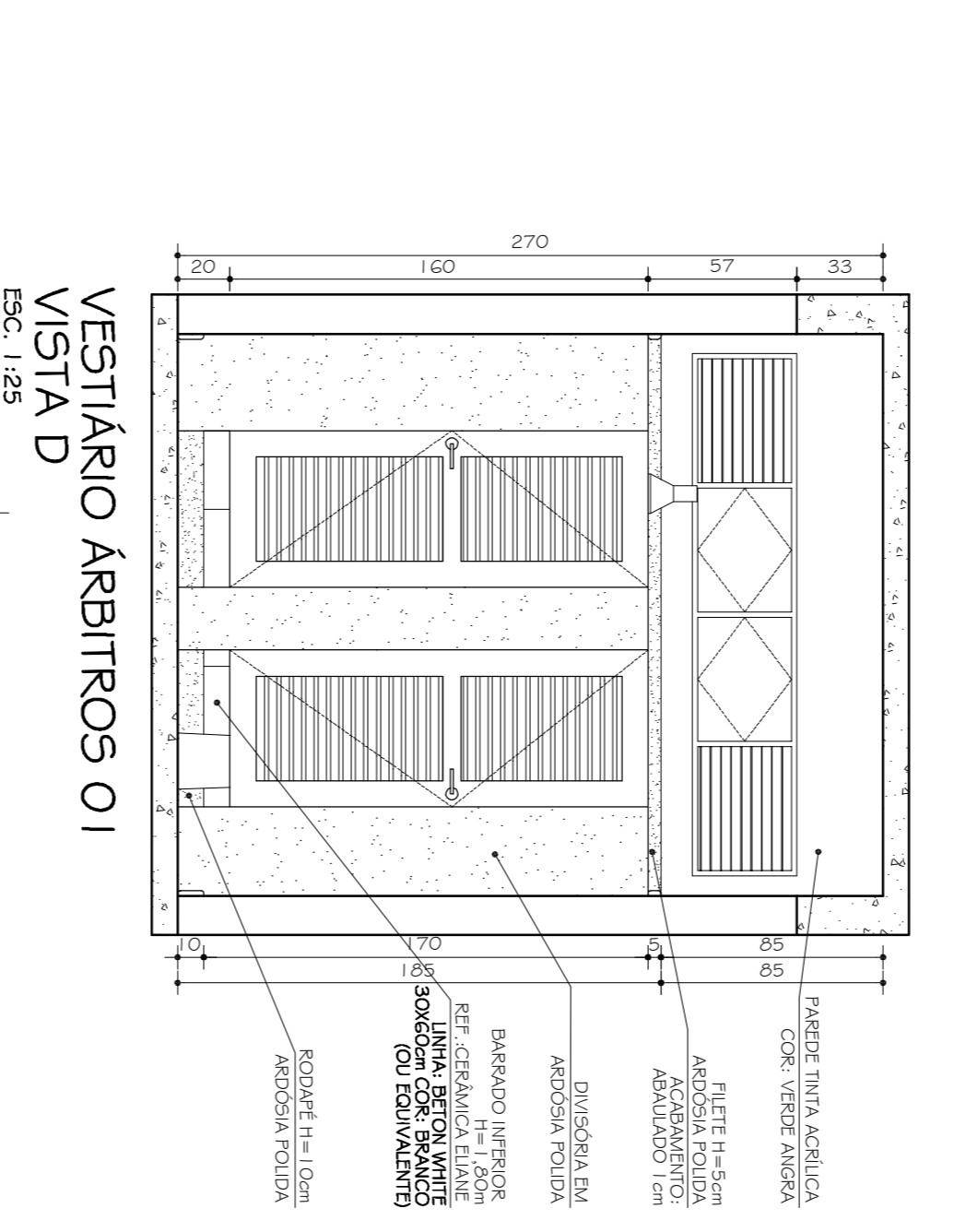
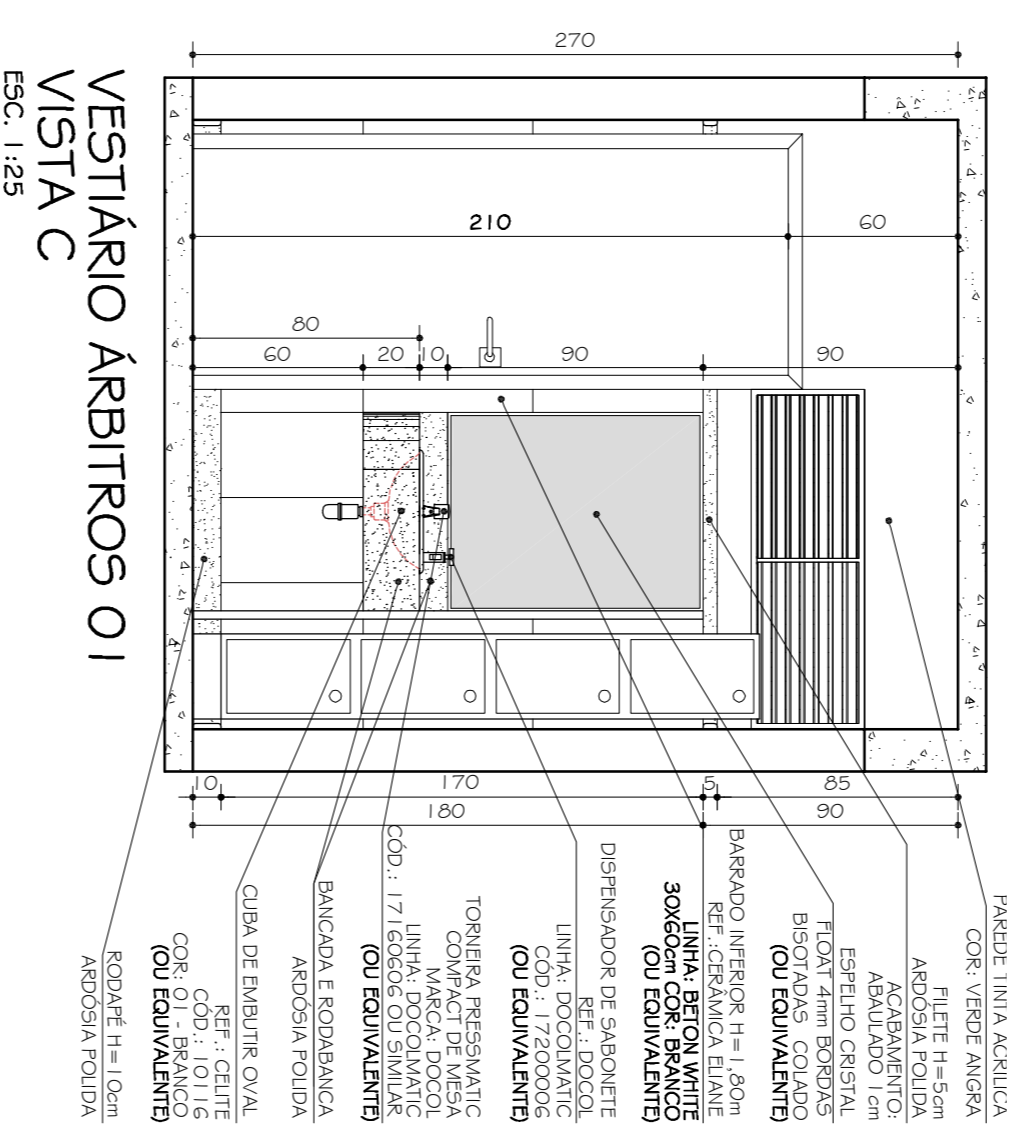

B02 - BANCADA
VESTIÁRIO ÁRTIBROS
PLANTA
ESC. 1:10

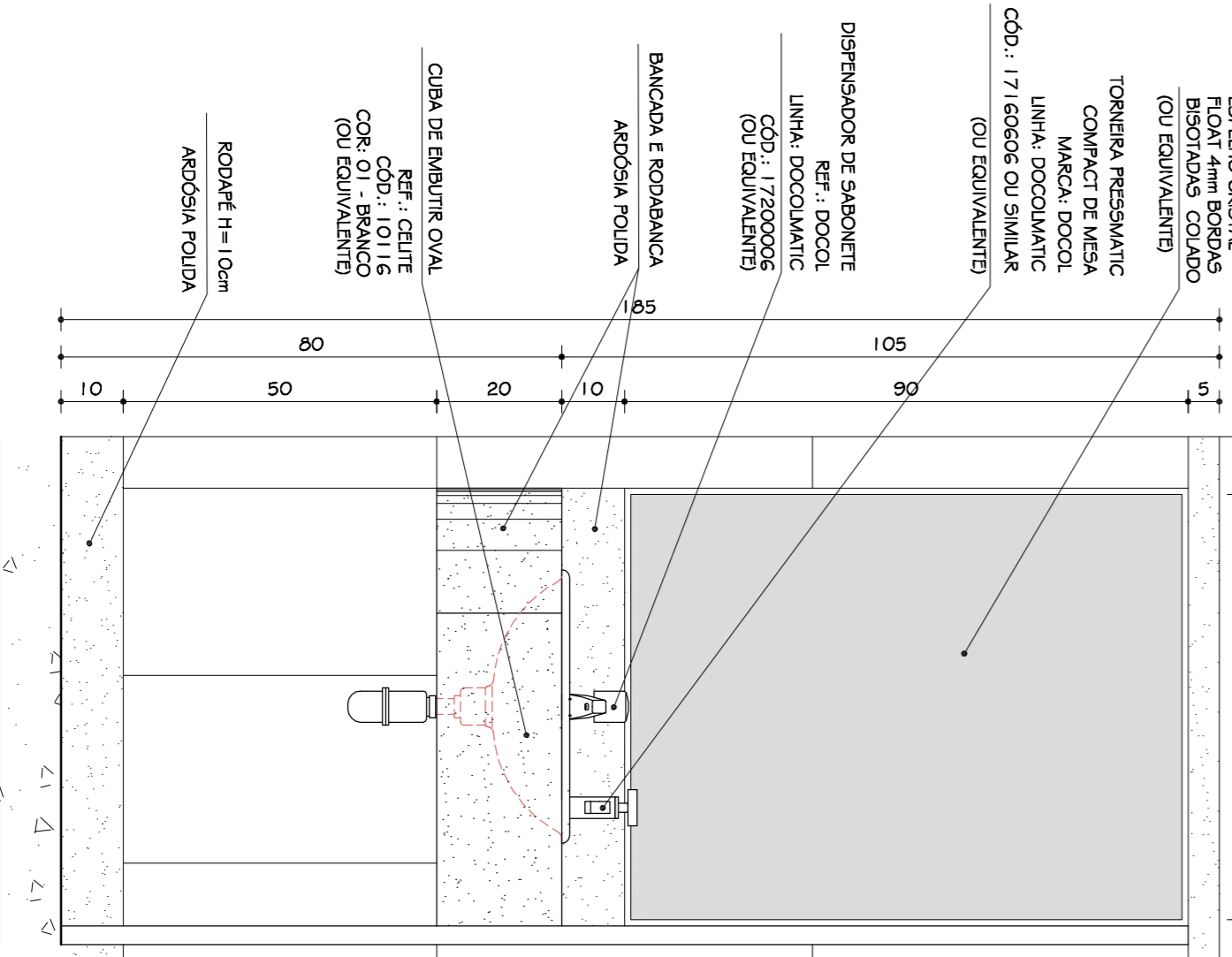

B02 - BANCADA
VESTIÁRIO ÁRTIBROS
VISTA A
ESC. 1:10

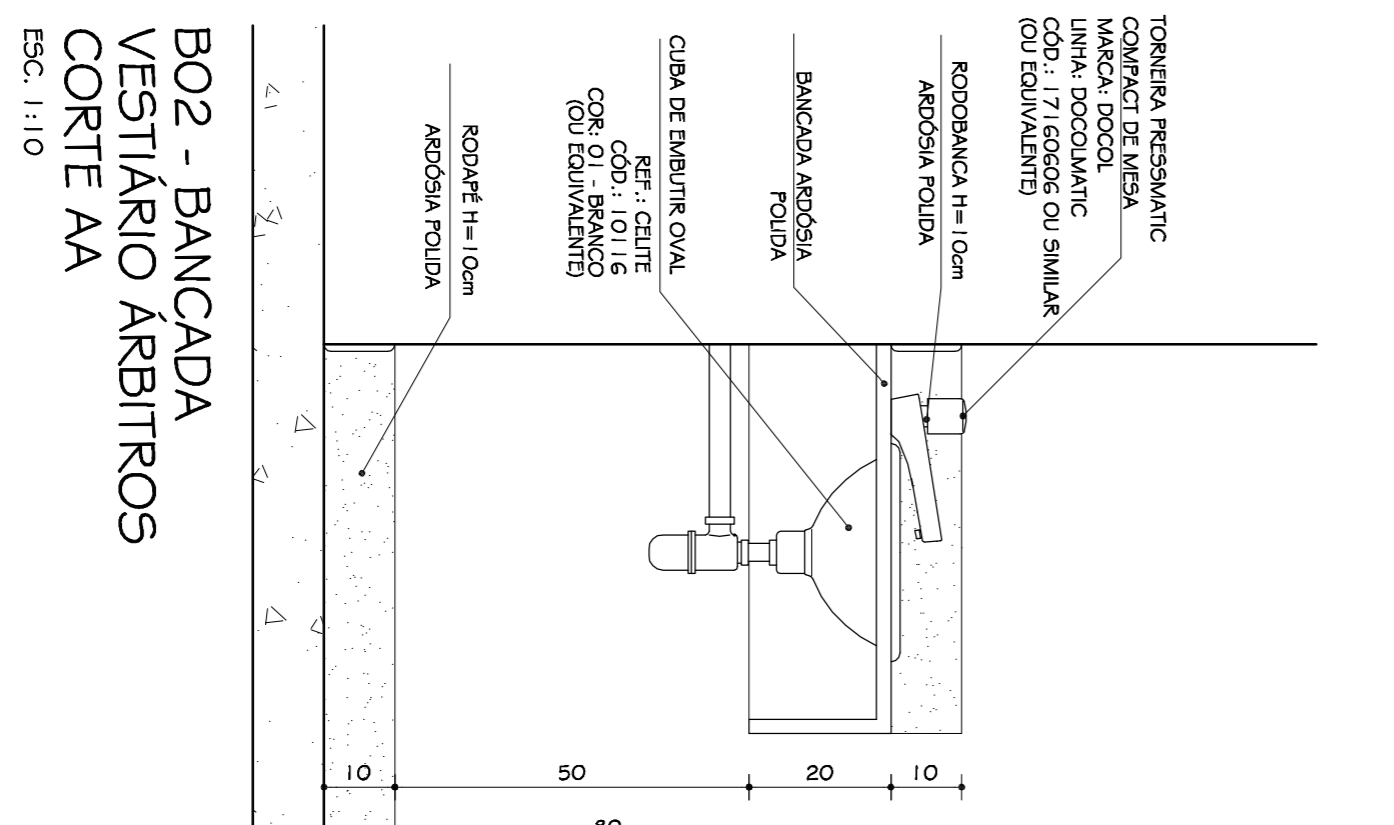

B02 - BANCADA
VESTIÁRIO ÁRTIBROS
CORTE AA
ESC. 1:10

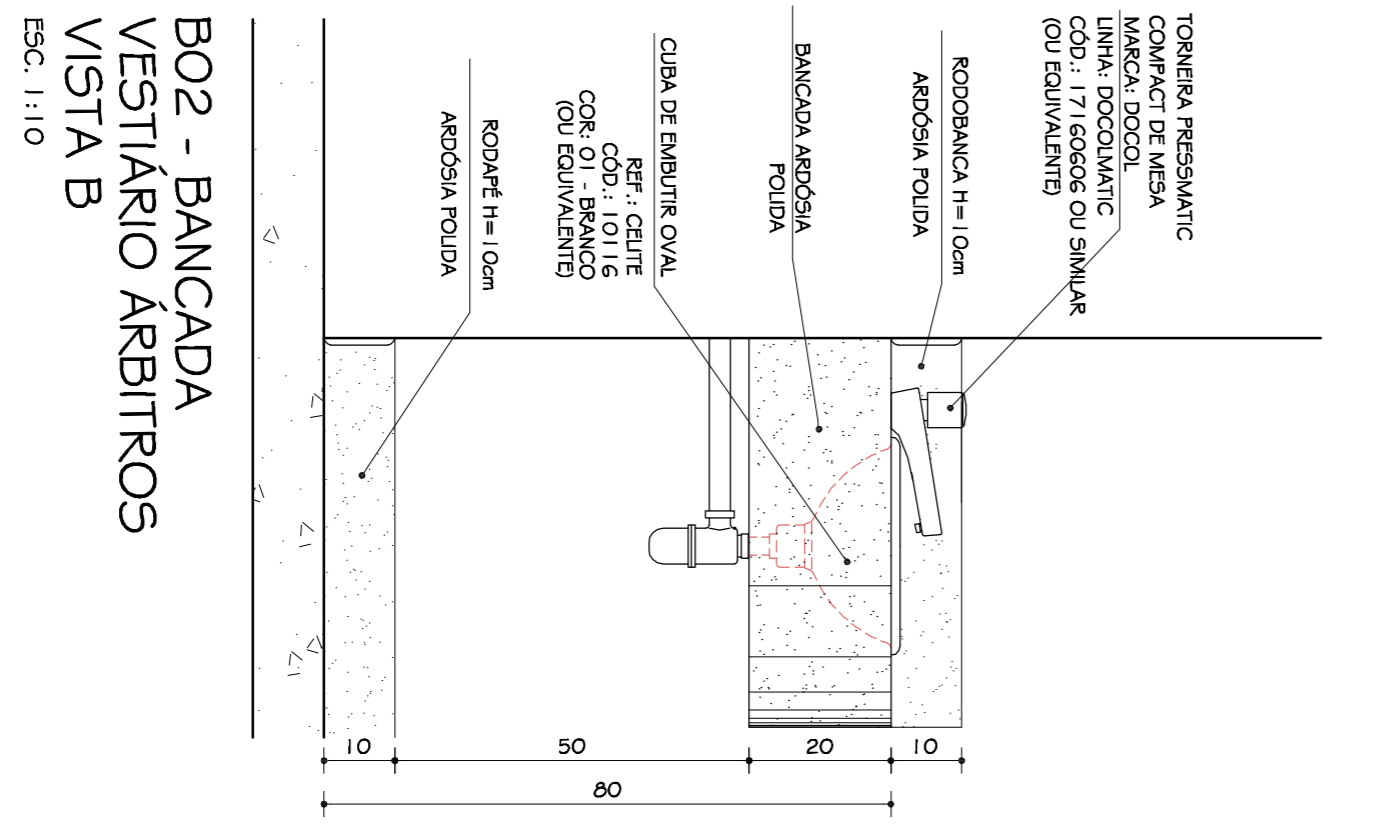

B02 - BANCADA
VESTIÁRIO ÁRTIBROS
VISTA B
ESC. 1:10

TABELA GERAL REVESTIMENTOS	
01	PISO CIMENTADO USADO / PINTURA MOVICOR QUADRA
02	CERÂMICA 41 x 20x20 / CORE: CINZA MÉDIO
03	PISO CIMENTADO (SERPENO) / PINTURA MOVICOR CUIXA
04	PINTURA TINTA LIVRE/ROSCA CORE: AMARELO OROXO
05	PINTURA TINTA LIVRE/ROSCA CORE: BRANCA
06	PINTURA TINTA LIVRE/ROSCA CORE: VERDE AZULADA
07	PINTURA TINTA LIVRE/ROSCA CORE: TERAÇOTA
08	PINTURA TINTA LIVRE/ROSCA CORE: AZULADA
09	PINTURA TINTA LIVRE/ROSCA CORE: CAULIÇA
10	PINTURA TINTA LIVRE/ROSCA CORE: PÉTO ROSCO
11	BARROADO CERÂMICO H=1,80cm CERÂMICA 30x30cm REF.: ELIANE/ LINHA BRITON WHITE 30x30cm CORE: BRANCO ACIMA PINTURA TINTA LIVRE CORE: FIBRADO H.S. FMA) CORE VERDE ANGRA H.S. MACÇ)
12	FÓRKO LATE COM PINTURA BRANCO NITE
13	TETA TRAPEZODAL COM PISOCEL BRANCO

PROJETO ARQUITETÔNICO EXECUTIVO CONFERIR MEDIDAS NA OBRA			
OBSERVAÇÕES			
GINÁSIO POLIESPORTIVO CAMPUS JK / DIAMANTINA			
RODOVIA MG 367, KM 593, Nº 5000 - AUTO DA JACIBA - DIAMANTINA/MG			
PROJETERIA: UNIVERSIDADE FEDERAL DOS VALES DO JACIBA - DIAMANTINA/MG		ORÇ: 16.888,31/50001-57	
AUTOR PROJETO ARQUITETÔNICO: REY CLÁUDIO DE MELO ROCHA		CREA: 66.4372/D - MG	
DETALHES VESTIÁRIO ÁRTIBROS - PLANTA E VISTAS, D01, D07, D07A, DOGA E B02			
DEFINIMENTOS: TRCC - TOMAZ RIZZOTTO ENGENHARIA E CONSTRUÇÕES LTDA			
VERSÃO: 1		DATA: 04.08.2009	FOIHA: 14/16
ARQUIVO: UFMJM_GINÁSIO_ÁRÇEQ_V01/FI.0-15_R03			